

JAY[®]

WHITMYER[®]

≡ Head Support Solutions



Whitmyer is a product line of head supports and accessories that addresses the range of user needs from basic support to multiple-point control. A variety of pad shapes and sizes are available in single, two-pad or three-pad systems with each pad designed to address a specific support purpose.

HEAD SUPPORTS



PLUSH



SPECIALTY PLUSH



CONTOUR CRADLE



S.O.F.T. SINGLE
SUB-OCCIPITAL



S.O.F.T. DUAL SUB-OCCIPITAL
Adult & Pediatric



HEADS UP



CUDDLES INFANT

HARDWARE SYSTEMS



AXYS



ONYX



LINX



PRO



COBRA XTRA
(Flip-Back shown)

This catalog was designed to help you clearly understand the Whitmyer headrest offering and to easily create a part number for each ordering.

TABLE OF CONTENTS

HEAD SUPPORTS

- PLUSH Single Pad Headrest 4
- SPECIALTY PLUSH Single Pad Headrest 6
- CONTOURED CRADLE Single Pad Headrest 8
- S.O.F.T. SINGLE SUB-OCCIPITAL 10
- S.O.F.T. DUAL SUB-OCCIPITAL Adult & Pediatric 12
- HEADS UP Anterior Head Support System 14
- CUDDLES INFANT Contoured Cradle or Triple Pad Headrest 16

ACCESSORIES

- LATERAL FACIAL SUPPORTS 17
- ANTERIOR SUPPORT OPTIONS 17

HARDWARE SYSTEMS

- AXYS 18
- ONYX 18
- LINX 18
- PRO 18
- COBRA XTRA & COBRA XTRA Flip Back 18
- CUSTOM MOUNTING OPTIONS 19

PLUSH Single Pad Headrest Systems utilize dual density foam layers on a contoured, curved panel. These single pad headrests are easily adjustable and accommodate changes or inconsistencies in body positioning. Unique "cupping" shape provides posterior support with a high degree of comfort and safety. This basic headrest is ideal for tilt/recline, and has the ability to add lateral support, anterior support, or switches as client's needs change. The larger size pads facilitate safety for clients with behavioral issues and active movements.

PLUSH



Check out the PLUSH's versatility and adjustability in action.

www.YouTube.com/user/JAYCushionsandBacks

Click on the playlist:

"Whitmyer Headrest Adjustment Systems"

Scan this QR code to view now!



PLUSH ORDERING GUIDE

DETERMINE PAD SIZE

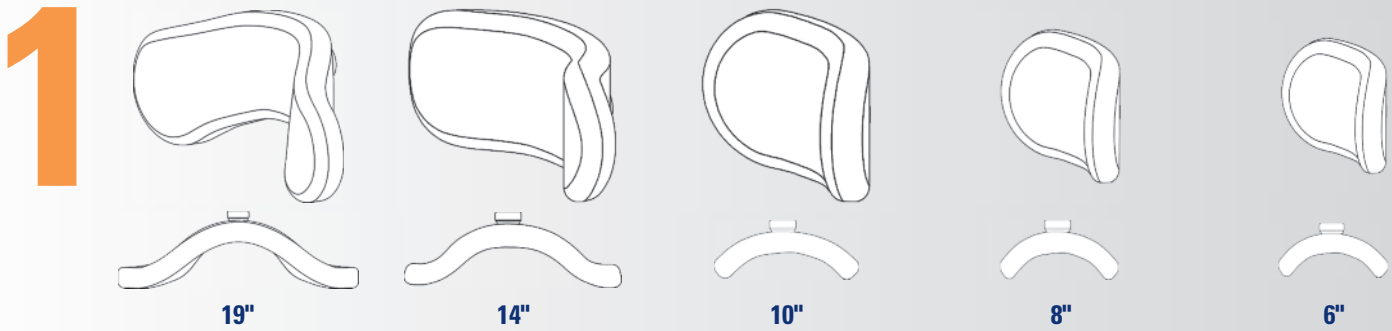

SELECT HARDWARE SYSTEM AND PAD COVER (BASED ON PAD SIZE)

2

	AXYS	ONYX	LINX	PRO	COBRA XTRA	COBRA XTRA Flip Back
Pad Size	Part Numbers (Cover selection: L =Lycra V =Dartex Reversed)					
19"	AXYS-P4 L AXYS-P4 V	ONYX-P4 L ONYX-P4 V	LINX-P4 L LINX-P4 V	PRO-P4 L PRO-P4 V	COBRA-P4 L COBRA-P4 V	FB-COBRA-P4 L FB-COBRA-P4 V
14"	AXYS-P2 L AXYS-P2 V	ONYX-P2 L ONYX-P2 V	LINX-P2 L LINX-P2 V	PRO-P2 L PRO-P2 V	COBRA-P2 L COBRA-P2 V	FB-COBRA-P2 L FB-COBRA-P2 V
10"	AXYS-P1 L AXYS-P1 V	ONYX-P1 L ONYX-P1 V	LINX-P1 L LINX-P1 V	PRO-P1 L PRO-P1 V	COBRA-P1 L COBRA-P1 V	FB-COBRA-P1 L FB-COBRA-P1 V
8"	AXYS-P3 L AXYS-P3 V	ONYX-P3 L ONYX-P3 V	LINX-P3 L LINX-P3 V	PRO-P3 L PRO-P3 V	COBRA-P3 L COBRA-P3 V	FB-COBRA-P3 L FB-COBRA-P3 V
6"	AXYS-P8 L AXYS-P8 V	ONYX-P8 L ONYX-P8 V	LINX-P8 L LINX-P8 V	PRO-P8 L PRO-P8 V	COBRA-P8 L COBRA-P8 V	FB-COBRA-P8 L FB-COBRA-P8 V

SELECT MOUNTING BRACKET FOR HARDWARE SYSTEM

3

	Mounting Brackets				
Detachable					COBRA XTRA Hardware System includes detachable mounting bracket.
	M2500	M2100-WB	M2300	M2200-WB	
Swing-Away					Select COBRA XTRA Flip Back Hardware System for swing-away capability.
	M5500	M5100	M5300	M5200	

Specialty PLUSH Single Pad Headrest Systems are formerly custom solutions that are now offered as part of the standard product line including Adjust-A-PLUSH (shown below), Dual Mount and 12" Narrow pads.

SPECIALTY PLUSH



ADJUST-A-PLUSH

Designed for use on clients that exhibit poor head control and require lateral support on at least one side to maintain an upright head posture. Assists in controlling passive and active lateral cervical flexion. Suitable for clients with poor targeting that require some degree of lateral confinement in their headrest. The Adjust-A-PLUSH has two tapered locking joints that can be narrowed or widened to provide maximum lateral support. Zippered cover hides adjustment points.

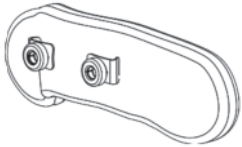

DUAL MOUNT PLUSH

An extra mount provides added strength making this head support ideal for high tone, high extension clients. The pad is offered in 19" and 14" widths.

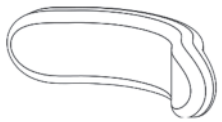

NARROW PLUSH

Offers low profile support in a 12" width.



Check out the SPECIALTY PLUSH's versatility and adjustability in action.

www.YouTube.com/user/JAYCushionsandBacks

Click on the playlist:

"Whitmyer Headrest Adjustment Systems"

Scan this QR code to view now!



SPECIALTY PLUSH ORDERING GUIDE

DETERMINE PAD SIZE

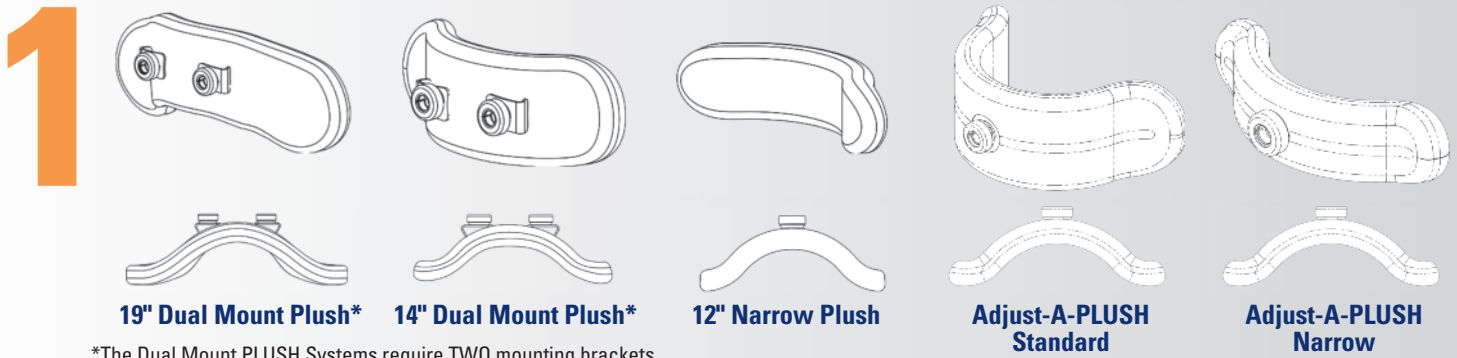

*The Dual Mount PLUSH Systems require TWO mounting brackets.

SELECT HARDWARE SYSTEM AND PAD COVER (BASED ON PAD SIZE)

2

	AXYS	ONYX	LINX	PRO	COBRA XTRA	COBRA XTRA Flip Back
Pad Size						
	Part Numbers (Cover selection: L =Lycra V =Dartex Reversed)					
19" Dual	AXYS-P44 L AXYS-P44 V	ONYX-P44 L ONYX-P44 V	LINX-P44 L LINX-P44 V	PRO-P44 L PRO-P44 V	-	-
14" Dual	AXYS-P22 L AXYS-P22 V	ONYX-P22 L ONYX-P22 V	LINX-P22 L LINX-P22 V	PRO-P22 L PRO-P22 V	-	-
12" Narrow	AXYS-P12 L AXYS-P12 V	ONYX-P12 L ONYX-P12 V	LINX-P12 L LINX-P12 V	PRO-P12 L PRO-P12 V	COBRA-P12 L COBRA-P12 V	FB-COBRA-P12 L FB-COBRA-P12 V
A-A-P Std	AXYS-AP2 L AXYS-AP2 V	ONYX-AP2 L ONYX-AP2 V	LINX-AP2 L LINX-AP2 V	PRO-AP2 L PRO-AP2 V	COBRA-AP2 L COBRA-AP2 V	FB-COBRA-AP2 L FB-COBRA-AP2 V
A-A-P Narrow	AXYS-AP1 L AXYS-AP1 V	ONYX-AP1 L ONYX-AP1 V	LINX-AP1 L LINX-AP1 V	PRO-AP1 L PRO-AP1 V	COBRA-AP1 L COBRA-AP1 V	FB-COBRA-AP1 L FB-COBRA-AP1 V

SELECT MOUNTING BRACKET FOR HARDWARE SYSTEM

3

	Mounting Brackets				
Detachable					COBRA XTRA Hardware System includes detachable mounting bracket.
	M2500	M2100-WB	M2300	M2200-WB	
Swing-Away					Select COBRA XTRA Flip Back Hardware System for swing-away capability.
	M5500	M5100	M5300	M5200	

Contoured Cradle Head Support's positioning success is derived from its unique anatomic shape. Generically designed to cradle the occiput and provide lateral cervical support, this unit supplies a high degree of comfort and positioning in a simple-to-adjust head support. A single rotational collar adjustment allows positioning for maximum support surface contact. Four pad sizes fit infant to adult. Add lateral facial pads, switches, and/or anterior support for more versatility.

CONTOURED CRADLE

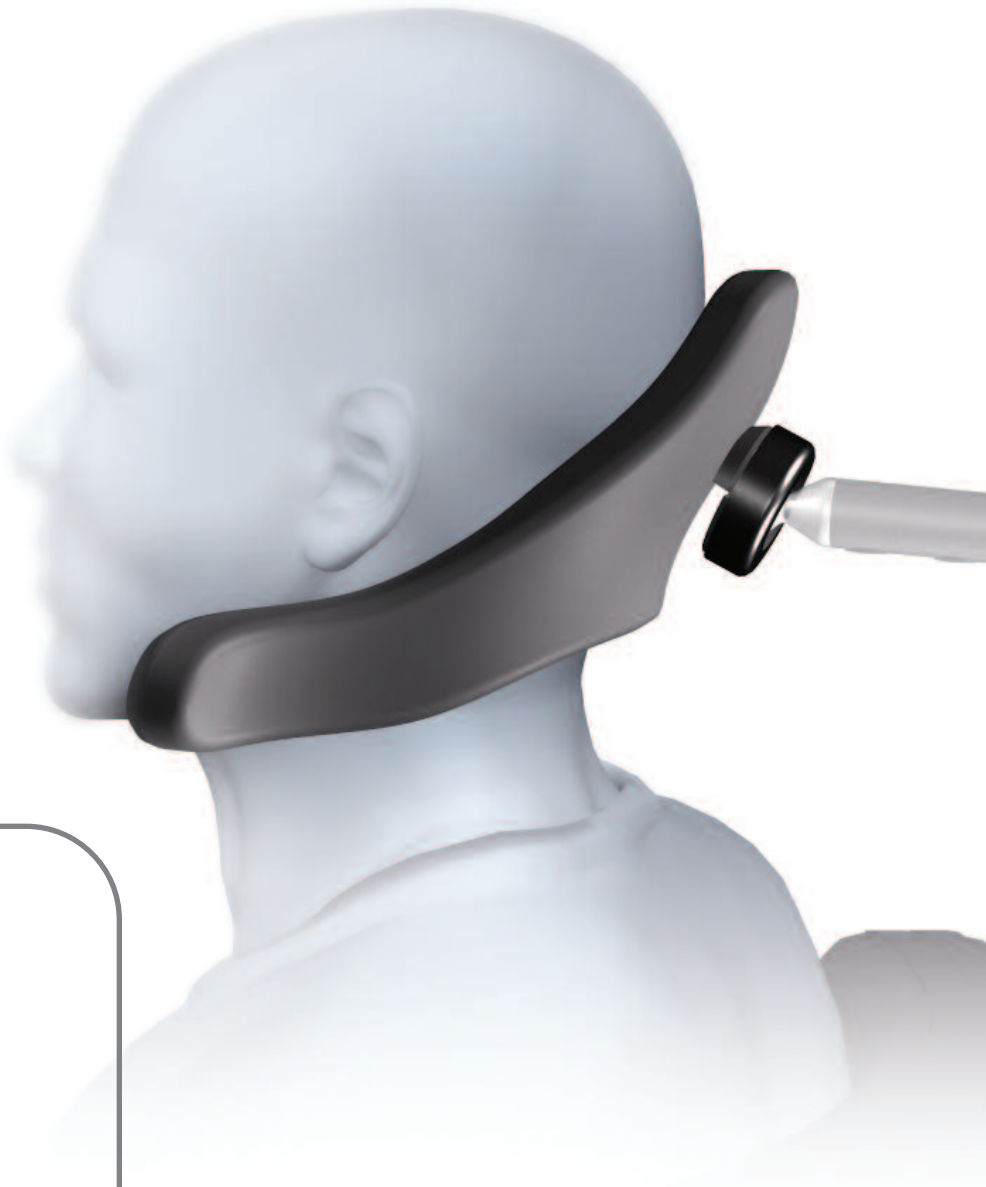

Check out the **CONTOURED CRADLE's** versatility and adjustability in action. Scan this QR code to view now!

www.YouTube.com/user/JAYCushionsandBacks

Click on the playlist:

"Whitmyer Headrest Adjustment Systems"



CONTOURED CRADLE ORDERING GUIDE

DETERMINE PAD SIZE

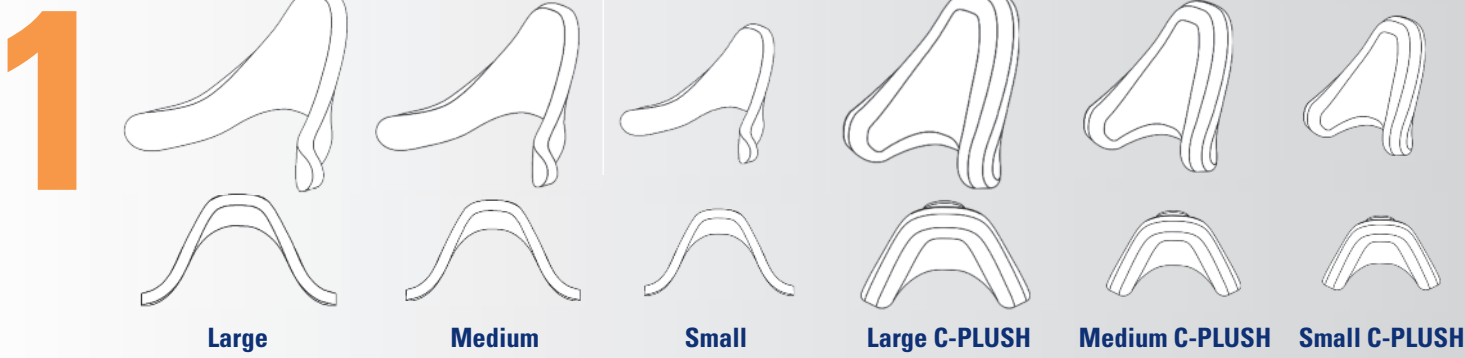

SELECT HARDWARE SYSTEM AND PAD COVER (BASED ON PAD SIZE)

2

	AXYS	ONYX	LINX	PRO	COBRA XTRA	COBRA XTRA Flip Back
Pad Size						
	Part Numbers (Cover selection: L =Lycra V =Dartex Reversed)					
Large	AXYS-CCS4 L AXYS-CCS4 V	ONYX-CCS4 L ONYX-CCS4 V	LINX-CCS4 L LINX-CCS4 V	PRO-CCS4 L PRO-CCS4 V	COBRA-CCS4 L COBRA-CCS4 V	FB-COBRA-CCS4 L FB-COBRA-CCS4 V
Med	AXYS-CCS3 L AXYS-CCS3 V	ONYX-CCS3 L ONYX-CCS3 V	LINX-CCS3 L LINX-CCS3 V	PRO-CCS3 L PRO-CCS3 V	COBRA-CCS3 L COBRA-CCS3 V	FB-COBRA-CCS3 L FB-COBRA-CCS3 V
Small	AXYS-CCS2 L AXYS-CCS2 V	ONYX-CCS2 L ONYX-CCS2 V	LINX-CCS2 L LINX-CCS2 V	PRO-CCS2 L PRO-CCS2 V	COBRA-CCS2 L COBRA-CCS2 V	FB-COBRA-CCS2 L FB-COBRA-CCS2 V
Large C-PLUSH	AXYS-CCP4 L AXYS-CCP4 V	ONYX-CCP4 L ONYX-CCP4 V	LINX-CCP4 L LINX-CCP4 V	PRO-CCP4 L PRO-CCP4 V	COBRA-CCP4 L COBRA-CCP4 V	FB-COBRA-CCP4 L FB-COBRA-CCP4 V
Med C-PLUSH	AXYS-CCP3 L AXYS-CCP3 V	ONYX-CCP3 L ONYX-CCP3 V	LINX-CCP3 L LINX-CCP3 V	PRO-CCP3 L PRO-CCP3 V	COBRA-CCP3 L COBRA-CCP3 V	FB-COBRA-CCP3 L FB-COBRA-CCP3 V
Small C-PLUSH	AXYS-CCP2 L AXYS-CCP2 V	ONYX-CCP2 L ONYX-CCP2 V	LINX-CCP2 L LINX-CCP2 V	PRO-CCP2 L PRO-CCP2 V	COBRA-CCP2 L COBRA-CCP2 V	FB-COBRA-CCP2 L FB-COBRA-CCP2 V

SELECT MOUNTING BRACKET FOR HARDWARE SYSTEM

3

	Mounting Brackets				
Detachable					COBRA XTRA Hardware System includes detachable mounting bracket.
	M2500	M2100-WB	M2300	M2200-WB	
Swing-Away					Select COBRA XTRA Flip Back Hardware System for swing-away capability.
	M5500	M5100	M5300	M5200	

S.O.F.T. Single Sub-occipital Head Supports supply sub-occipital and proximal lateral cervical support via a single curved sub-occipital pad. Unique to our single sub-occipital system is the independent anterior/posterior occipital pad movement. Consistent, repeatable positioning of the client is required for best performance. The addition of lateral facial pads, switches, and anterior supports increase this system's versatility.

S.O.F.T. SINGLE SUB-OCCIPITAL



Check out the S.O.F.T.'s versatility and adjustability in action.

www.YouTube.com/user/JAYCushionsandBacks

Click on the playlist:

"Whitmyer Headrest Adjustment Systems"

Scan this QR code to view now!



S.O.F.T. SINGLE ORDERING GUIDE

DETERMINE PAD SIZE

1

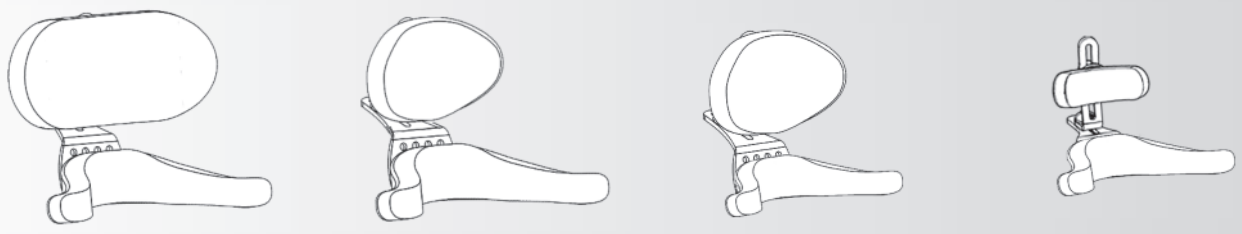

SS10
10" PLUSH occipital w/Adult Single Sub-occipital





SS8
Adult occipital w/Adult Single Sub-occipital

SS4
Adult occipital w/Pediatric Single Sub-occipital

SS3
Pediatric occipital w/Pediatric Single Sub-occipital

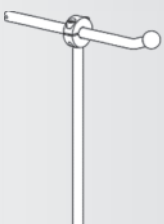

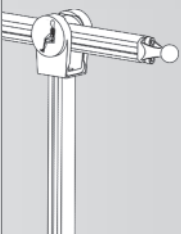

SELECT HARDWARE SYSTEM AND PAD COVER (BASED ON PAD SIZE)

2

	AXYS	ONYX	LINX	PRO	COBRA XTRA	COBRA XTRA Flip Back
Pad Size						
	Part Numbers (Cover selection: L=Lycra V=Dartex Reversed)					
SS10	AXYS-SS10 L AXYS-SS10 V	ONYX-SS10 L ONYX-SS10 V	LINX-SS10 L LINX-SS10 V	PRO-SS10 L PRO-SS10 V	COBRA-SS10 L COBRA-SS10 V	FB-COBRA-SS10 L FB-COBRA-SS10 V
SS8	AXYS-SS8 L AXYS-SS8 V	ONYX-SS8 L ONYX-SS8 V	LINX-SS8 L LINX-SS8 V	PRO-SS8 L PRO-SS8 V	COBRA-SS8 L COBRA-SS8 V	FB-COBRA-SS8 L FB-COBRA-SS8 V
SS4	AXYS-SS4 L AXYS-SS4 V	ONYX-SS4 L ONYX-SS4 V	LINX-SS4 L LINX-SS4 V	PRO-SS4 L PRO-SS4 V	COBRA-SS4 L COBRA-SS4 V	FB-COBRA-SS4 L FB-COBRA-SS4 V
SS3	AXYS-SS3 L AXYS-SS3 V	ONYX-SS3 L ONYX-SS3 V	LINX-SS3 L LINX-SS3 V	PRO-SS3 L PRO-SS3 V	COBRA-SS3 L COBRA-SS3 V	FB-COBRA-SS3 L FB-COBRA-SS3 V

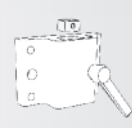
SELECT MOUNTING BRACKET FOR HARDWARE SYSTEM

3

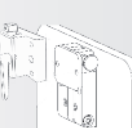
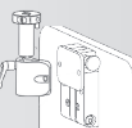
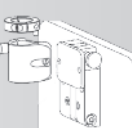
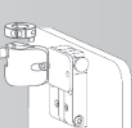
	Mounting Brackets				
Detachable	 M2500	 M2100-WB	 M2300	 M2200-WB	COBRA XTRA Hardware System includes detachable mounting bracket.
Swing-Away	 M5500	 M5100	 M5300	 M5200	

S.O.F.T. Three Pad Head Supports solve the most challenging head positioning issues. This patented device combines two width and rotationally adjustable sub-occipital pads with an adjustable occipital pad for independent anterior/posterior movement. The added adjustability of the individual suboccipital pads allows adjustment to asymmetrical postures and deformities. This unique pad configuration supplies maximum occipital and proximal lateral cervical support for more aggressive positioning and comfort. Consistent, repeatable positioning of the client is required for best performance. Attaching lateral facial pads, switches, and/or anterior supports adds to this system's versatility.

S.O.F.T. DUAL SUB-OCCIPITAL

ADULT & PEDIATRIC

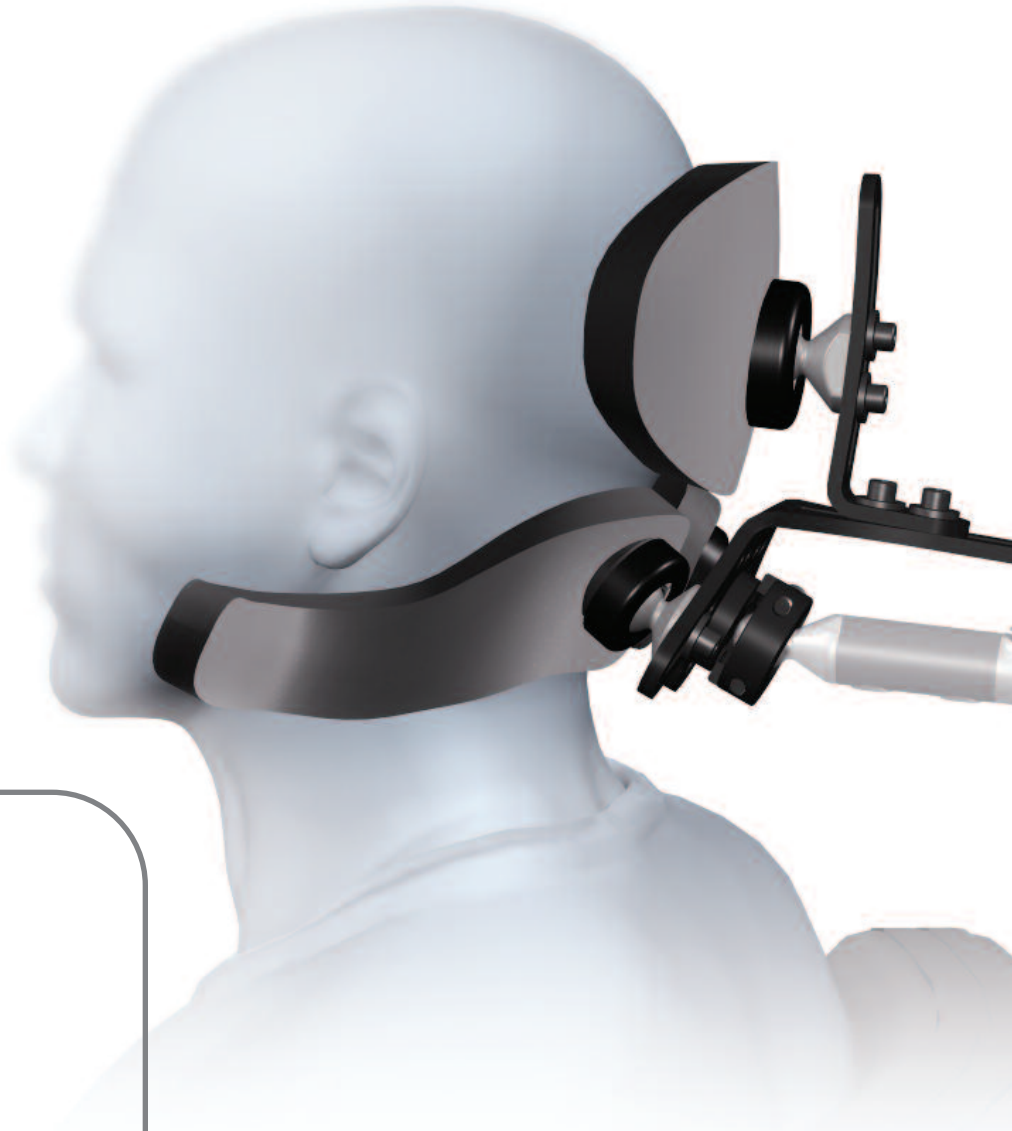

Check out the S.O.F.T.'s versatility and adjustability in action.

www.YouTube.com/user/JAYCushionsandBacks

Click on the playlist:

"Whitmyer Headrest Adjustment Systems"

Scan this QR code to view now!



S.O.F.T. DUAL ORDERING GUIDE

DETERMINE PAD SIZE

1

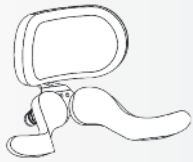

8– 8" PLUSH occipital w/Size-1 Sub-occipitals



5– 10" PLUSH occipital w/Size-1 Sub-occipitals

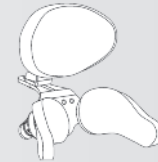

2– Adult occipital w/Size-2 Sub-occipitals

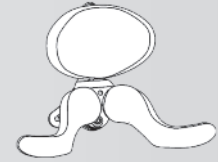

1– Adult occipital w/Size-1 Sub-occipitals

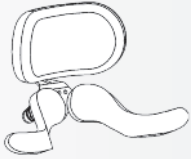

7– 8" PLUSH occipital w/Size-3 Sub-occipitals

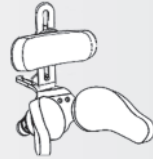

6– Pediatric occipital w/Size-4 Sub-occipitals

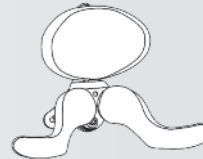

4– Adult occipital w/Size-3 Sub-occipitals

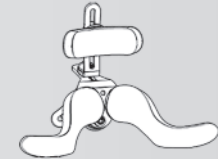

3– Pediatric occipital w/Size-3 Sub-occipitals

SELECT HARDWARE SYSTEM AND PAD COVER (BASED ON PAD SIZE)

2

	AXYS	ONYX	LINX	PRO	COBRA XTRA	COBRA XTRA Flip Back
	Part Numbers (Cover selection: L=Lycra V=Dartex Reversed)					
8	AXYS-8 L AXYS-8 V	ONYX-8 L ONYX-8 V	LINX-8 L LINX-8 V	PRO-8 L PRO-8 V	COBRA-8 L COBRA-8 V	FB-COBRA-8 L FB-COBRA-8 V
5	AXYS-5 L AXYS-5 V	ONYX-5 L ONYX-5 V	LINX-5 L LINX-5 V	PRO-5 L PRO-5 V	COBRA-5 L COBRA-5 V	FB-COBRA-5 L FB-COBRA-5 V
2	AXYS-2 L AXYS-2 V	ONYX-2 L ONYX-2 V	LINX-2 L LINX-2 V	PRO-2 L PRO-2 V	COBRA-2 L COBRA-2 V	FB-COBRA-2 L FB-COBRA-2 V
1	AXYS-1 L AXYS-1 V	ONYX-1 L ONYX-1 V	LINX-1 L LINX-1 V	PRO-1 L PRO-1 V	COBRA-1 L COBRA-1 V	FB-COBRA-1 L FB-COBRA-1 V
7	AXYS-7 L AXYS-7 V	ONYX-7 L ONYX-7 V	LINX-7 L LINX-7 V	PRO-7 L PRO-7 V	COBRA-7 L COBRA-7 V	FB-COBRA-7 L FB-COBRA-7 V
6	AXYS-6 L AXYS-6 V	ONYX-6 L ONYX-6 V	LINX-6 L LINX-6 V	PRO-6 L PRO-6 V	COBRA-6 L COBRA-6 V	FB-COBRA-6 L FB-COBRA-6 V
4	AXYS-4 L AXYS-4 V	ONYX-4 L ONYX-4 V	LINX-4 L LINX-4 V	PRO-4 L PRO-4 V	COBRA-4 L COBRA-4 V	FB-COBRA-4 L FB-COBRA-4 V
3	AXYS-3 L AXYS-3 V	ONYX-3 L ONYX-3 V	LINX-3 L LINX-3 V	PRO-3 L PRO-3 V	COBRA-3 L COBRA-3 V	FB-COBRA-3 L FB-COBRA-3 V

SELECT MOUNTING BRACKET FOR HARDWARE SYSTEM

3

	Mounting Brackets				
Detachable					COBRA XTRA Hardware System includes detachable mounting bracket.
	M2500	M2100-WB	M2300	M2200-WB	
Swing-Away					Select COBRA XTRA Flip Back Hardware System for swing-away capability.
	M5500	M5100	M5300	M5200	

The Heads Up is an innovative head support designed to maximize clients' interaction with their environment by providing anterior, posterior and lateral support of the head and neck. It features swing-out, adjustable arms to easily accommodate client transfers and varying client presentations.

HEADS UP

ANTERIOR AND LATERAL STABILIZATION OF SHOULDERS AND TRUNK FOR OPTIMAL HEAD CONTROL

- Innovative anterior stabilization arms
- Swing-out for easy transfer that maintains head support
- Lower lateral adjustments to accommodate varying body shapes



TWO DIFFERENT INDUSTRY-PROVEN POSTERIOR SUPPORT OPTIONS:

- Contoured Cradle
- Single Sub-Occipital

CHIN PAD INCLUDED



Check out the HEADS UP's versatility and adjustability in action.

www.YouTube.com/user/JAYCushionsandBacks

Click on the playlist:

"Whitmyer Headrest Adjustment Systems"

Scan this QR code to view now!



HEADS UP ORDERING GUIDE

The Heads Up features easy to create Smart Part numbers for configuring the headrest. Follow the 8 easy steps below to generate a head support part # and mounting bracket that can be added into our online ordering system or ordered through customer service.

EXAMPLE SMART PART #: **AXYS-HU-ITSSL:** Heads Up with AXYS Hardware - Infant Size, Tall Height, + Short Arms, Standard Foam, Lycra (Neoprene) Cover
M2500: AXYS Mounting Bracket

1 SELECT HARDWARE SYSTEM Begin part # with hardware selection followed by -HU for Heads Up

AXYS	ONYX	LINX	PRO	COBRA XTRA	COBRA XTRA Flip Back
AXYS-HU-	ONYX-HU-	LINX-HU-	PRO-HU-	COBRA-HU-	FBCOB-HU-

2 SELECT NECK WIDTH (MAXIMUM) Add Selection to Smart Part

Infant (2.8")	Small (3.5")	Medium (4.1")	Large (5.3")
I	S	M	L

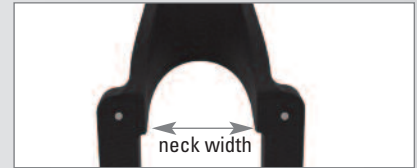

3 SELECT PAD HEIGHT Add Selection to Smart Part

Tall	Short
T	S



4 SELECT SWING-OUT SUPPORT ARM LENGTH Add Selection to Smart Part

Short	Long
S	L



Infant & Small	Medium & Large
Short: 5.6"	Short: 7"
Long: 7.3"	Long: 9"

5 SELECT FOAM TYPE Add Selection to Smart Part

Standard	Comfort
S	C

	Infant	Small	Medium	Large
Standard	0.4"	0.5"	0.6"	0.7"
Comfort	0.6"	0.6"	0.8"	0.9"

6 SELECT COVER Add Selection to Smart Part

Lycra (Neoprene)	Reversed Dartex
L	V

IF YOU DO NOT WANT TO ADD AN OCCIPITAL PAD, YOUR PART NUMBER FOR THE HEAD SUPPORT IS COMPLETE. PLEASE PROCEED TO STEP 8 TO SELECT MOUNTING BRACKET.

7 SELECT OPTIONAL OCCIPITAL PAD* Add Selection to Smart Part

*Available on short heights only.

Pediatric 5" Pad (for Short Infant size)	Adult 6" Pad (for Short Small size)	Plush 8" Pad (for Short Medium size)	Plush 10" Pad (for Short Large size)
-O5	-O6	-O8	-O10

8 SELECT MOUNTING BRACKET Add part # separate from the Smart Part

		Mounting Brackets for:					
		AXYS	ONYX	LINX	PRO	COBRA XTRA	COBRA XTRA Flip Back
Detachable	M2500	M2100-WB	M2300	M2200-WB	COBRA XTRA Hardware System includes detachable mounting bracket.		
Swing-Away	M5500	M5100	M5300	M5200	Select COBRA XTRA Flip Back Hardware System for swing-away capability.		

Cuddles infant three pad head support and contoured cradle head support offer the same innovative technology as the adult versions, just sized for an infant.

CUDDLES INFANT



ORDERING GUIDE

DETERMINE PAD SIZE

1

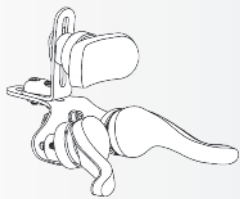

S.O.F.T. Infant Occipital w/Infant Sub-occipitals



CCS Infant Contoured Cradle Pad

SELECT HARDWARE SYSTEM AND PAD COVER (BASED ON PAD SIZE)

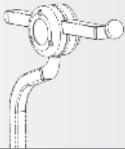

2

Pad Size	AXYS	ONYX
		
	Part Numbers	
S.O.F.T.	AXYS-INFT L AXYS-INFT V	ONYX-INFT L ONYX-INFT V
CCS	AXYS-CCS1 L AXYS-CCS1 V	ONYX-CCS1 L ONYX-CCS1 V

Cover selection:
L=Lycra
V=Dartex Reversed

SELECT MOUNTING BRACKET FOR HARDWARE SYSTEM

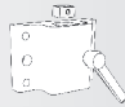
3

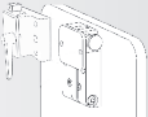
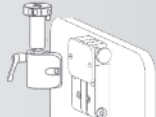
		Mounting Brackets	
Detachable			
	M2500	M2100-WB	
Swing-Away			
	M5500	M5100	

CUDDLES INFANT ANTERIOR & LATERAL SUPPORTS

Forehead Strap



INFT500

Unilateral Support



INFT700

Bilateral Support



INFT750

Check out the CUDDLES INFANT's versatility and adjustability in action.

www.YouTube.com/user/JAYCushionsandBacks

Click on the playlist:

"Whitmyer Headrest Adjustment Systems"

Scan this QR code to view now!



Lateral Facial Pads can be configured to accommodate or block lateral flexion deviations and/or rotation patterns or function to supply general support surfaces or switch placement above the cervical level. A rearward mounting hardware pivot point allows the pads to move out-of-the-way during transfers or when not in use. Curved ball rods allow placement of pads around the head laterally or anteriorly. A choice of 7 uniquely shaped pad sizes, 5 of which are malleable; ensure the ability to match the pad with the area needing support.

LATERAL FACIAL SUPPORTS

Part numbers for the pads and hardware are listed below.
Hardware is swing-away and must be ordered with the pad part number.

NOTE: All lateral supports come with swing-away hardware

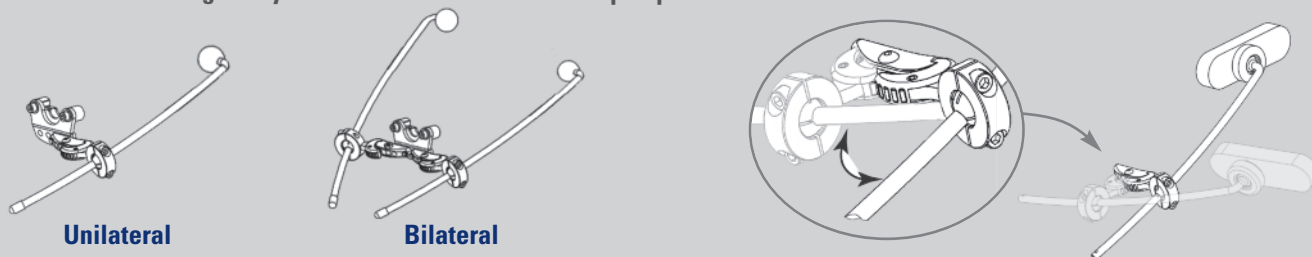

SPOT	STANDARD	LONG	OVAL	LARGE-C	MED-C	SMALL-C	FSO-B

Part Numbers Cover selection: Add L=Lycra or V=Dartex Reversed. Example: LFC-PLL

	Plush & Spec.Plush LFC10-PL & LM115	Plush & Spec.Plush LFC15-PL & LM115	Plush & Spec.Plush LFC20-PL & LM115	Plush & Spec.Plush LFC25-PL & LM115	Plush & Spec.Plush LFC30-PL & LM115	Plush & Spec.Plush LFC35-PL & LM115	Plush & Spec.Plush LFC40-PL & LM115	Plush & Spec.Plush LFC80-PL & LM115
UniLateral	Cont.Cradle/Heads Up LFC10-CS & LM115	Cont.Cradle/Heads Up LFC15-CS & LM115	Cont.Cradle/Heads Up LFC20-CS & LM115	Cont.Cradle/Heads Up LFC25-CS & LM115	Cont.Cradle/Heads Up LFC30-CS & LM115	Cont.Cradle/Heads Up LFC35-CS & LM115	Cont.Cradle/Heads Up LFC40-CS & LM115	Cont.Cradle/Heads Up LFC80-CS & LM115
	S.O.F.T. Single,Adult/Peds LFC10 & LM115	S.O.F.T. Single,Adult/Peds LFC15 & LM115	S.O.F.T. Single,Adult/Peds LFC20 & LM115	S.O.F.T. Single,Adult/Peds LFC25 & LM115	S.O.F.T. Single,Adult/Peds LFC30 & LM115	S.O.F.T. Single,Adult/Peds LFC35 & LM115	S.O.F.T. Single,Adult/Peds LFC40 & LM115	S.O.F.T. Single,Adult/Peds LFC80 & LM115
	Plush & Spec.Plush LFC10-PL2 & (2) LM115	Plush & Spec.Plush LFC15-PL2 & (2) LM115	Plush & Spec.Plush LFC20-PL2 & (2) LM115	Plush & Spec.Plush LFC25-PL2 & (2) LM115	Plush & Spec.Plush LFC30-PL2 & (2) LM115	Plush & Spec.Plush LFC35-PL2 & (2) LM115	Plush & Spec.Plush LFC40-PL2 & (2) LM115	Plush & Spec.Plush LFC80-PL2 & (2) LM115
BiLateral	Cont.Cradle/Heads Up LFC10-CS2 & (2) LM115	Cont.Cradle/Heads Up LFC15-CS2 & (2) LM115	Cont.Cradle/Heads Up LFC20-CS2 & (2) LM115	Cont.Cradle/Heads Up LFC25-CS2 & (2) LM115	Cont.Cradle/Heads Up LFC30-CS2 & (2) LM115	Cont.Cradle/Heads Up LFC35-CS2 & (2) LM115	Cont.Cradle/Heads Up LFC40-CS2 & (2) LM115	Cont.Cradle/Heads Up LFC80-CS2 & (2) LM115
	S.O.F.T. Single,Adult/Peds (2) LFC10 & (2) LM115	S.O.F.T. Single,Adult/Peds (2) LFC15 & (2) LM115	S.O.F.T. Single,Adult/Peds (2) LFC20 & (2) LM115	S.O.F.T. Single,Adult/Peds (2) LFC25 & (2) LM115	S.O.F.T. Single,Adult/Peds (2) LFC30 & (2) LM115	S.O.F.T. Single,Adult/Peds (2) LFC35 & (2) LM115	S.O.F.T. Single,Adult/Peds (2) LFC40 & (2) LM115	S.O.F.T. Single,Adult/Peds (2) LFC80 & (2) LM115
	Plush & Spec.Plush LFC10-PL2 & (2) LM115	Plush & Spec.Plush LFC15-PL2 & (2) LM115	Plush & Spec.Plush LFC20-PL2 & (2) LM115	Plush & Spec.Plush LFC25-PL2 & (2) LM115	Plush & Spec.Plush LFC30-PL2 & (2) LM115	Plush & Spec.Plush LFC35-PL2 & (2) LM115	Plush & Spec.Plush LFC40-PL2 & (2) LM115	Plush & Spec.Plush LFC80-PL2 & (2) LM115

Anterior Supports are excellent for low tone individuals with poor head balance, individuals exhibiting forward flexion patterns, or individuals who require an upright head position for medical reasons, i.e. compromised respiration and swallowing. Successfully used for task oriented applications, such as classroom interaction or during meals. The addition of a Strap Cap brings a low profile solution to anterior support for individuals who may not be successful with the strap.

ANTERIOR SUPPORT OPTIONS

	DYNAMIC FOREHEAD STRAP	DFS ²	STRAP CAP	STATIC FOREHEAD STRAP
	Part Numbers			
Adult	DFS10	DFSQ10	CAP10 (black)	HU10
Peds	DFS30	DFSQ30	CAP30-R (red) CAP30-B (blue)	HU10

MOUNTING HARDWARE OPTIONS

Each head support pad is available with most of the hardware options listed below. Part numbers for order can be found on the detailed head support product pages.

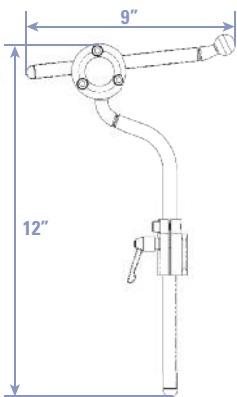

Part #: AX7010

AXYS is a compact mounting system that features a black chrome finish combined with a 1/2" steel square rod. It was designed for rigorous applications, ease of adjustment, and simple modifications.

Height: 12"
Horizontal Depth: 6"
Pitch Adjustment: 30°

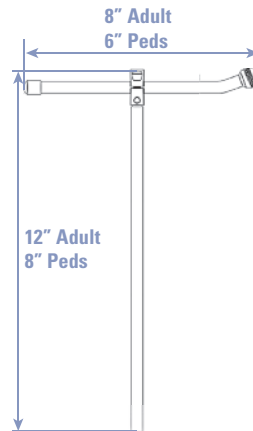

Part # Adult: OX7010
Part # Peds: OX7030

ONYX is a compact mounting solution that features a black chrome finish combined with a small profile 7/8" steel rod. It was designed for rigorous applications, ease of adjustment, and simple modifications.

Pediatric
Height adjustment: 8"
Horizontal Depth Adj: 1" to 6"
Pitch Adjustment: 30°

Adult
Height adjustment: 11"
Horizontal Depth Adj: 1" to 8"
Pitch Adjustment: 30°

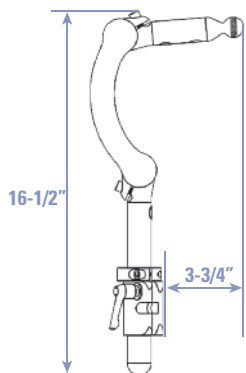

Part #: LX7000

LINX is a contemporary styled mounting hardware that combines two simple, unique points of adjustment which allows full anterior/posterior fluid movement, creating an infinite range of support surface placement. It features satin black tubing with contrasting polished aluminum clamps and knurled mounting ball ensures stay-in-place adjustments.

Height adjustment: 7"
Horizontal Depth: 8.5" forward, 3/4" rearward
Pitch Adjustment: 30°

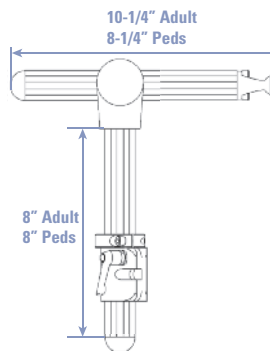

Part # Adult: PRC7010
Part # Peds: PRC7030

The **PRO** Mounting System is a proven hardware option for demanding applications. This mounting system features 1.25" aluminum extrusion and is ideal for use when client strength or strong tonal patterns are an issue.

Pediatric
Height adjustment: 6"
Horizontal Depth Adj: 1.5" forward, 6" rearward
Pitch Adjustment: 45°

Adult
Height adjustment: 6"
Horizontal Depth Adj: 1.5" forward, 8" rearward
Pitch Adjustment: 45°

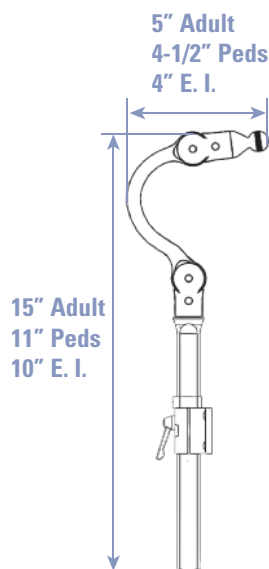

Part # Adult: CBRA7010
Part # Peds: CBRA7030
Part # E.I.: CBRA7080

The **COBRA XTRA** Mounting System incorporates a sleek and unobtrusive design that eliminates protrusions towards the rear of the chair. With superior strength and positioning range, the COBRA XTRA Mounting System is available in Small (Early Intervention and Pediatric), Medium (Pediatric), and Large (Adult). The components are modular and easily changed in the field to enable exact positioning of the head support pad – even if the user's head position changes from the time of the initial prescription.

Adult
Height adjustment: 6.5"
Horizontal Depth Adj: 6.5" forward, 2" rearward
Pitch Adjustment: 30°

Pediatric
Height adjustment: 3.5"
Horizontal Depth Adj: 5" forward, 1.5" rearward
Pitch Adjustment: 30°

Early Intervention
Height adjustment: 3.5"
Horizontal Depth Adj: 4" forward, 1/2" rearward
Pitch Adjustment: 30°

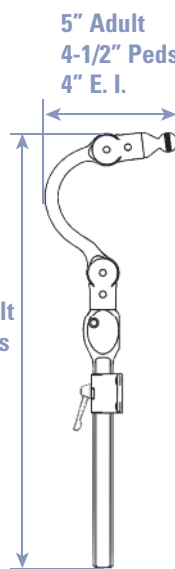

Part # Adult: CBRA5010
Part # Peds: CBRA5030
Part # E.I.: CBRA5080

The **COBRA XTRA Flip Back** Mounting System is operated by a single push-button on the side of the bracket and neatly flips the assembly back behind the wheelchair back. With superior strength and positioning range, the COBRA XTRA Flip Back Mounting System is available in Small (Early Intervention and Pediatric), Medium (Pediatric), and Large (Adult). The components are modular and easily changed in the field to enable exact positioning of the head support pad – even if the user's head position changes from the time of the initial prescription.

Adult
Height adjustment: 6.5"
Horizontal Depth Adj: 6.5" forward, 2" rearward
Pitch Adjustment: 30°

Pediatric
Height adjustment: 3.5"
Horizontal Depth Adj: 5" forward, 1.5" rearward
Pitch Adjustment: 30°

Early Intervention
Height adjustment: 3.5"
Horizontal Depth Adj: 4" forward, 1/2" rearward
Pitch Adjustment: 30°

CUSTOM MOUNTING OPTIONS

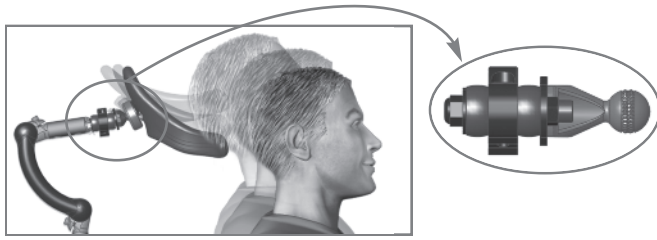

FLEX INTERFACE BRACKET

The Flex Interface Bracket provides upward flex, travel, and return when the head support is extended against. This dynamic motion assists in maintaining head support contact throughout the user's extensor pattern. The Flex Interface Bracket utilizes elastomeric bushings engineered to supply the correct resistance-to-force while allowing the head support to return to the adjusted position. Used between the head support mount and contact surface, the Flex Interface Bracket can be used with most Whitmyer head support accessories.

Part Number: M9450

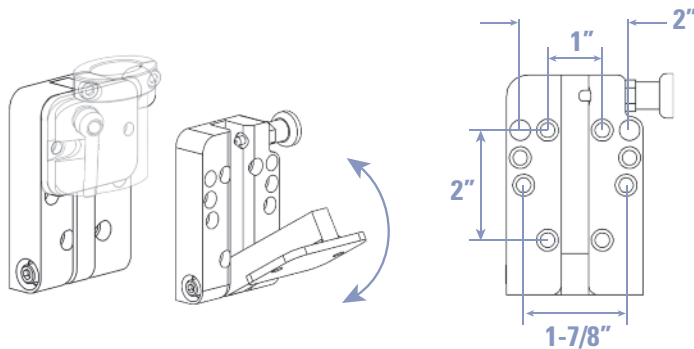

UNIVERSAL SWING-AWAY MOUNT

Whitmyer detach brackets attach to our universal swing-away mount. When attached to the swing-away mount, the assembly becomes a combination detach/swing-away mounting bracket.

Part Number: M5000

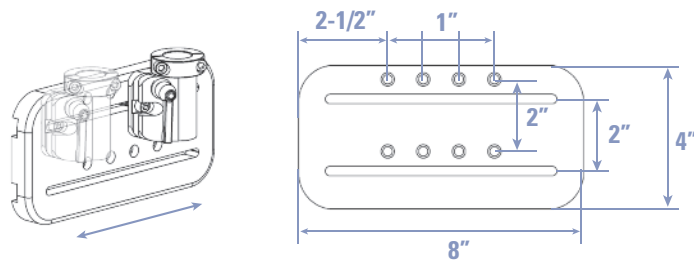

SLIDE MOUNT

This slotted plastic plate allows the headrest/head support to be positioned in a more perpendicular fashion behind the head of individuals who present with a significant amount of asymmetry. The plate bolts into the chair's existing hole pattern and allows 4" of movement left or right. Perfect for trying off-set head support locations, adjusting for misplaced T-nut locations and relocating the head support to be more in line with the direction of applied forces.

Part Number: M7010

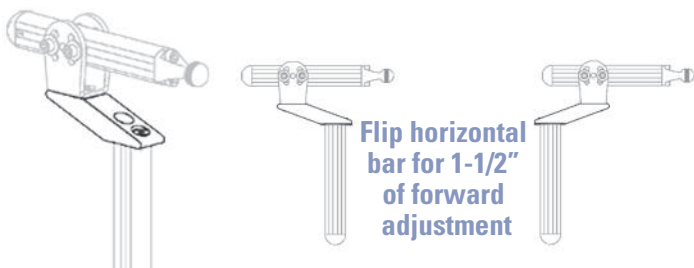

PRO OFF-SET MOUNTING SYSTEM

PRO system off-set bracket provides 2-1/2" of rearward adjustment to the horizontal bar. Flipping the horizontal bar will also allow for 2-1/2" of forward adjustment.

Part Number: PRC7070

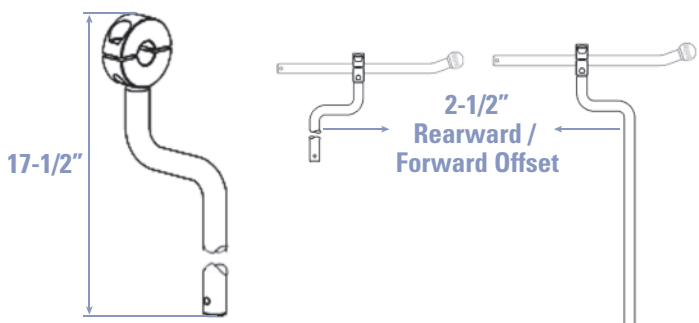

ONYX REARWARD OFF-SET VERTICAL ROD

ONYX off-set vertical rod provides 2-1/2" of rearward/forward adjustment to the horizontal rod.

Part Number: OX6030

Whitmyer Head Supports can be ordered with any Quickie®, Zippie® or Breezy® mobility product base and as a great addition to a JAY® standard or custom seating solution. Order them together to ensure compatibility prior to shipment and save time and money with ONE ORDER and ONE INVOICE.

Sunrise MobilityLink



Adult Manual



Q7 GT GP/GPV QRi Q2 Lite Q2 Q2 HP LXI/LX QXi M6 IRIS SR45 TS

Power



QM-710 QM-715 HD QM-720 Pulse 6 S-636 S-646 SE P-222 SE



Pediatric



ZONE GS Kidz Zippie 2 GS IRIS TS Xpress TLC Mighty Lite



Standard



600 Ultra 4 EC 4000 EC 4000 Recliner EC 3000 EC 2000 EC 2000 HD EC Transport



Cushions



J3 Fusion Lite J2 J2 Deep Contour J2 Plus



Xtreme Union Ion Easy Care Duo



Soft Combi P Active J-Gel GS G0 Zip Basic

Custom Seating



ShurShape SureFit ConfigureFit

Backs



J3 J2 J2 Deep Contour



J2 Plus SPO Basic



Care Precision Focus Point



Modular G0 Zip Encompass



Customer Service: 800.333.4000
www.SunriseMedical.com

©02.2013 Sunrise Medical (US) LLC
MKT3000-3 Rev. E